

# ASYMMETRIC DUO

- exciting contrast between the clear lines of the bath rim and the flowing, ergonomic design language of the interior
- generously sized storage area that can also be used as a sit or to accommodate bath rim tap fittings
- enamelled waste cover and overflow knob integrated in the bath design (also available with filling function)
- bathing with a friend: two identical back rests and centrally positioned waste
- made of KALDEWEI steel enamel

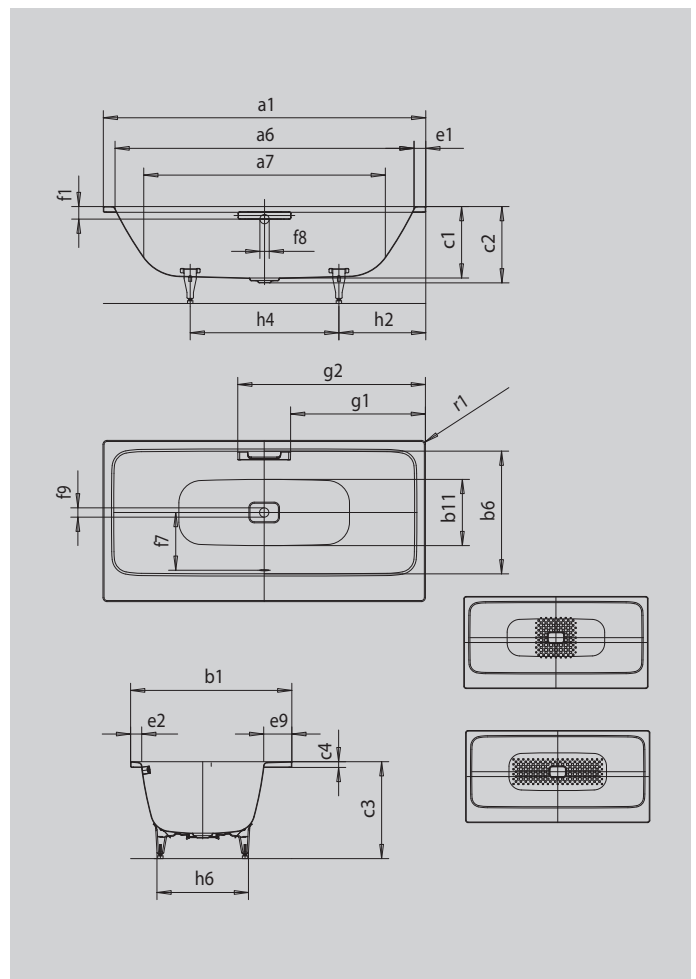

Similar illustration



Model		742
External length	a <sub>1</sub>	1800 mm
Internal length (top)	a <sub>6</sub>	1670 mm
Internal length (bottom)	a <sub>7</sub>	1348 mm
External width	b <sub>1</sub>	900 mm
Internal width (top)	b <sub>6</sub>	681 mm
Internal width (bottom)	b <sub>11</sub>	600 mm
Depth inside	c <sub>1</sub>	400 mm
Depth incl. waste hole	c <sub>2</sub>	425 mm
Height with feet	c <sub>3</sub>	540 - 560 mm
Height of rim	c <sub>4</sub>	32 mm
Shelf	e <sub>9</sub>	157 mm
Width of rim (foot end; long side)	e <sub>1</sub> ; e <sub>2</sub>	65; 62 mm
Distance top edge to centre of overflow hole	f <sub>1</sub>	70 mm
Distance bath edge to centre of waste hole	f <sub>2</sub>	900 mm
Distance centre of waste hole to centre of overflow hole	f <sub>7</sub>	335 mm
Diameter of overflow hole	f <sub>8</sub>	Ø 52 mm
Diameter of waste hole	f <sub>9</sub>	Ø 52 mm
Distance bath edge (foot end) to start of grip	g <sub>1</sub>	753 mm
Distance bath edge (foot end) to end of grip	g <sub>2</sub>	1048 mm
Distance foot end of bath edge to centre of foot	h <sub>2</sub>	580 mm
Distance between the feet	h <sub>4</sub>	640 mm
Width of feet max.	h <sub>6</sub>	525 mm
External radius	r <sub>1</sub>	23 mm
Water volume		163 l
Net weight		52 kg
Anti-slip		396 x 396 mm
Full anti-slip		876 x 252 mm