

INCAVA

- this bath defines itself by its organically flowing interior
- sensually soft corner radius
- the precise, striking wall surrounds the bath like a picture frame lending it a sculptural character
- also available with grip on one side
- enamelled waste cover and overflow knob integrated in the bath design (also available with filling function)
- bathing with a friend: two identical back rests and centrally positioned waste
- made of KALDEWEI steel enamel
- designed by Anke Salomon

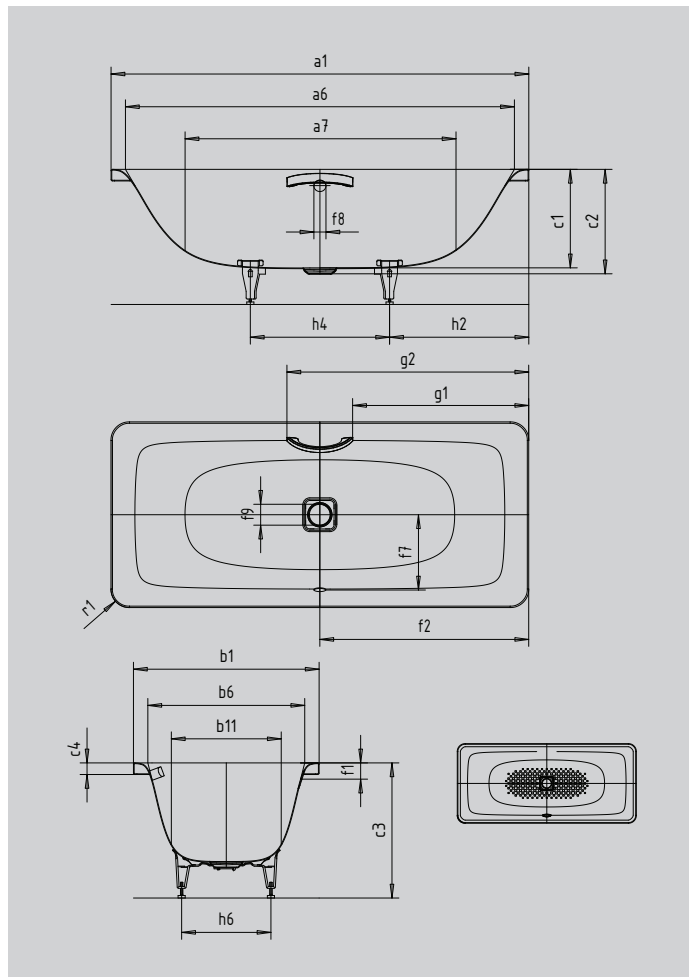

Similar illustration



Model		176
External length	a ₁	1900 mm
Internal length (top)	a ₆	1776 mm
Internal length (bottom)	a ₇	1262 mm
External width	b ₁	900 mm
Internal width (top)	b ₆	776 mm
Internal width (bottom)	b ₁₁	537 mm
Depth inside	c ₁	425 mm
Depth incl. waste hole	c ₂	450 mm
Height with feet	c ₃	565 - 602 mm
Height of rim	c ₄	50 mm
Distance top edge to centre of overflow hole	f ₁	70 mm
Distance bath edge to centre of waste hole	f ₂	950 mm
Distance centre of waste hole to centre of overflow hole	f ₇	362 mm
Diameter of overflow hole	f ₈	Ø 52 mm
Diameter of waste hole	f ₉	Ø 90 mm
Distance bath edge (foot end) to start of grip	g ₁	808 mm
Distance bath edge (foot end) to end of grip	g ₂	1092 mm
Distance foot end of bath edge to centre of foot	h ₂	591 mm
Distance between the feet	h ₄	718 mm
Width of feet max.	h ₆	430 mm
External radius	r ₁	80 mm
Water volume		188 l
Net weight		64 kg
Full anti-slip		924 x 348 mm